



JASON

**LAWN & GARDEN
REPLACEMENT BELTS**

MXV™ Series
OEM
FHP Multi-Plus®

HOW TO USE THE JASON CROSS-REFERENCING GUIDE

It's Quick & Easy!

1. Simply look up the OEM manufacturer's part number on pages 7 - 8. Listed next to it is a cross-reference to MXV or standard Multi-Plus belt. Special OEM belts are listed on pages 5 - 6.

2. What if the belt I am trying to replace has no part number on it (or I can't read it)? Using the Belt Construction Reference on pages 11 - 12, determine the cross-section, then measure the outside length of the belt.

For example, a belt that has 1/2" top width and measures 35" in circumference would be cross-referenced into either a A33(4L350) or a MXV4-350 (Mega-Power).

3. Which do I use - MXV or Standard Multi-Plus belts?

Most manufacturer's part numbers can be cross-referenced into either a standard FHP/Classical belt or a Multi-Plus belt. If given a choice, we recommend the MXV belt, especially for lawn and garden equipment. It is a little more expensive, but provides longer life and fewer breakdowns. An MXV belt may be substituted for a standard Multi-Plus V-belt. The reverse, however, is not always true. A Multi-Plus belt simply may not work on a drive designed for a stronger belt and definitely where clutching idlers are used.

Some guidelines in deciding which type of belt to use:

HORSEPOWER - Whenever the motor horsepower is greater than 5 or the service life of a Multi-Plus belt is less than desired, move up to the premium MXV Mega-Power belt.

CLUTCHING - If the belt must clutch (gradually engage the drive), use the MXV Mega-Power belt. It has a "dry" cover fabric specially designed to allow it to clutch. If clutching is not a requirement, the standard Multi-Plus may be used.

BACKSIDE IDLER - While the Multi-Plus belt will operate with a backside idler, MXV belt is designed for longer life when used on a drive where a backside idler is used.

All references to original equipment manufacturers, their trade names and their part numbers, listed in this catalog are used for identification purposes only. It is not our intention to imply that the merchandise is original equipment.

Any reference to Original Equipment Manufacturers, their trade names or stock numbers in this catalog is for identification purpose only.

The replacement recommendations contained in this catalog are not, in all cases, intended to be identical to the belt specifications of the original equipment manufacturer. Reasonable performance and availability are the major considerations in arriving at these selections. Where clutching drives are involved, extreme caution must be exercised to assure correct belt recommendations are used.

WARNING

Aramid Cable Cord — Since MXV belts feature high strength aramid tensile cords, shocks can be transmitted that exceed the strength of some cast pulleys. Carefully check the condition of your equipment, keep all guards in place, and consult the manufacturer if replacing standard belts with high strength aramid cord belts on cast pulleys.

THE PROFESSIONAL SELECTION

ARAMID CORD - (MXV) Heavy Duty

Professional Aramid Cord, premium wrapped belts are designed for engine-powered applications and designed to handle the most demanding applications - from riding mowers to edgers and tillers. These belts have an extra long life, even when used in clutching and backside idler applications.

The Professional Aramid belts provide performance advantages over fractional horsepower belts:

- Aramid Cord provides a high tensile strength for severe shock load and stretch resistance. Aramid is pound for pound stronger than steel - it's the same material used in bullet proof vests!
- Lowered cord position within the MXV belt is a major performance advantage in backside idler applications.
- Our special clutching cover provides smooth engagement and prevents accidental engagement in clutching applications. This cover protects the belt from heat associated with clutching. It also allows smooth belt engagement and reduces the "grabbing" effect that can cause accidental belt engagement common with standard belts.



POLY CORD - (MULTI-PLUS®) Standard Duty

Professional Poly Cord belts are high quality standard duty replacement belt for use in less demanding applications, designed and constructed for motor powered applications. These belts are made from premium quality synthetic rubber compounds, and feature high-strength polyester cords.

These poly cord belts offer an economical alternative to the Aramid cord belts while still providing outstanding quality.



OEM Exact (XP) Replacement

The OEM Exact Replacement belts are of the highest quality, made to exact OEM specifications. These belts offer exact length and top width dimensions, and are guaranteed to meet or exceed OEM tolerances. While most of our Aramid and Poly Cord belts are interchangeable with the exact replacement belts we offer, if we make an OEM exact belt available, we recommend selecting that belt. We carry exact replacements because of their non-standard size or because we have determined that they offer superior performance.



For Lawn and Garden Power Equipment

Aramid Cable Cord Construction - Built for Strength and Endurance

The Jason MXV Premium V-belt is designed to provide optimum performance on demanding outdoor power equipment in use today, as well as all other light-duty FHP drives.

- Superior Tensile Strength
- De-Clutching Cover
- Longer Drive Life
- Superior Length Stability
- Greater Heat/Oil Resistance

APPLICATIONS: Power Mowers • Riding Mowers/Garden Tractors • Tillers
Snow Throwers • Sprayer Pumps

MXV3 3/8" Top Width x 7/32" Thick x 40° Angle											
Belt No.	Outside Length	List Each	Belt No.	Outside Length	List Each	Belt No.	Outside Length	List Each	Belt No.	Outside Length	List Each
MXV3-200	20"	\$ 9.44	MXV3-280	28"	\$ 9.92	MXV3-350	35"	\$ 11.04	MXV3-420	42"	\$12.56
MXV3-210	21"	9.44	MXV3-290	29"	10.56	MXV3-360	36"	11.20	MXV3-430	43"	12.72
MXV3-220	22"	9.44	MXV3-300	30"	10.24	MXV3-370	37"	11.44	MXV3-440	44"	12.88
MXV3-240	24"	9.44	MXV3-310	31"	10.32	MXV3-380	38"	11.74	MXV3-450	45"	13.12
MXV3-250	25"	9.92	MXV3-320	32"	10.48	MXV3-390	39"	11.92	MXV3-460	46"	13.28
MXV3-260	26"	9.92	MXV3-330	33"	10.64	MXV3-400	40"	12.16	MXV3-470	47"	13.52
MXV3-270	27"	9.92	MXV3-340	34"	10.80	MXV3-410	41"	12.40	MXV3-480	48"	13.68
MXV4 1/2" Top Width x 5/16" Thick x 40° Angle											
MXV4-200	20"	\$ 9.92	MXV4-410	41"	\$13.04	MXV4-660	66"	\$17.60	MXV4-910	91"	\$24.48
MXV4-210	21"	9.92	MXV4-420	42"	13.20	MXV4-670	67"	17.76	MXV4-920	92"	24.80
MXV4-220	22"	9.92	MXV4-430	43"	13.44	MXV4-680	68"	18.00	MXV4-930	93"	25.12
MXV4-230	23"	9.92	MXV4-440	44"	13.76	MXV4-690	69"	18.24	MXV4-940	94"	25.36
MXV4-240	24"	9.92	MXV4-450	45"	14.00	MXV4-700	70"	18.40	MXV4-945	94.5"	25.48
MXV4-250	25"	9.92	MXV4-460	46"	14.16	MXV4-710	71"	18.80	MXV4-950	95"	25.60
MXV4-260	26"	10.08	MXV4-470	47"	14.32	MXV4-720	72"	19.20	MXV4-960	96"	25.92
MXV4-270	27"	10.24	MXV4-480	48"	14.40	MXV4-730	73"	19.36	MXV4-970	97"	26.16
MXV4-280	28"	10.40	MXV4-490	49"	14.56	MXV4-740	74"	19.44	MXV4-980	98"	26.40
MXV4-290	29"	10.56	MXV4-500	50"	14.72	MXV4-750	75"	19.60	MXV4-990	99"	26.72
MXV4-295	29.5"	10.72	MXV4-510	51"	14.88	MXV4-760	76"	19.76	MXV4-1000	100"	26.96
MXV4-300	30"	10.72	MXV4-520	52"	15.04	MXV4-770	77"	20.00	MXV4-1010	101"	27.23
MXV4-305	30.5"	10.88	MXV4-530	53"	15.20	MXV4-780	78"	20.32	MXV4-1020	102"	27.54
MXV4-310	31"	10.88	MXV4-540	54"	15.36	MXV4-790	79"	20.64	MXV4-1030	103"	27.70
MXV4-320	32"	11.04	MXV4-550	55"	15.52	MXV4-800	80"	20.96	MXV4-1050	105"	28.20
MXV4-325	32.5"	11.12	MXV4-560	56"	15.76	MXV4-810	81"	21.28	MXV4-1070	107"	28.89
MXV4-330	33"	11.20	MXV4-570	57"	15.92	MXV4-820	82"	21.60	MXV4-1080	108"	29.16
MXV4-340	34"	11.44	MXV4-580	58"	16.08	MXV4-830	83"	21.92	MXV4-1090	109"	29.38
MXV4-350	35"	11.44	MXV4-590	59"	16.28	MXV4-840	84"	22.24	MXV4-1100	110"	29.41
MXV4-355	35.5"	12.80	MXV4-600	60"	16.48	MXV4-850	85"	22.56	MXV4-1120	112"	30.12
MXV4-360	36"	11.84	MXV4-610	61"	16.64	MXV4-860	86"	22.88	MXV4-1180	118"	31.86
MXV4-370	37"	12.00	MXV4-620	62"	16.80	MXV4-870	87"	23.20	MXV4-1340	134"	36.13
MXV4-380	38"	12.24	MXV4-630	63"	17.04	MXV4-880	88"	23.52	MXV4-1380	138"	37.26
MXV4-390	39"	12.56	MXV4-640	64"	17.20	MXV4-890	89"	23.84			
MXV4-400	40"	12.80	MXV4-650	65"	17.44	MXV4-900	90"	24.16			
MXV5 21/32" Top Width x 3/8" Thick x 40° Angle											
MXV5-230	23"	\$12.16	MXV5-280	28"	\$13.04	MXV5-330	33"	\$14.56	MXV5-380	38"	\$16.00
MXV5-240	24"	12.16	MXV5-290	29"	13.36	MXV5-340	34"	14.88	MXV5-390	39"	16.48
MXV5-250	25"	12.16	MXV5-300	30"	13.60	MXV5-350	35"	15.12	MXV5-400	40"	17.12
MXV5-260	26"	12.48	MXV5-310	31"	13.92	MXV5-360	36"	15.44	MXV5-410	41"	17.60
MXV5-270	27"	12.80	MXV5-320	32"	14.24	MXV5-370	37"	15.68	MXV5-420	42"	18.00

High Performance (MXV) Lawn & Garden Equipment V-Belts

MXV5 2¹/₃₂" Top Width x 3³/₈" Thick x 40° Angle

Belt No.	Outside Length	List Each	Belt No.	Outside Length	List Each	Belt No.	Outside Length	List Each	Belt No.	Outside Length	List Each
MXV5-430	43"	\$18.40	MXV5-630	63"	\$24.00	MXV5-830	83"	\$30.80	MXV5-1040	104"	\$43.99
MXV5-440	44"	18.80	MXV5-640	64"	24.32	MXV5-840	84"	31.20	MXV5-1060	106"	44.84
MXV5-450	45"	19.20	MXV5-650	65"	24.64	MXV5-850	85"	32.00	MXV5-1090	109"	46.11
MXV5-460	46"	19.60	MXV5-660	66"	24.96	MXV5-860	86"	32.24	MXV5-1110	111"	46.95
MXV5-470	47"	20.00	MXV5-670	67"	25.28	MXV5-870	87"	32.56	MXV5-1130	113"	47.80
MXV5-480	48"	20.40	MXV5-680	68"	25.60	MXV5-880	88"	32.80	MXV5-1170	117"	49.49
MXV5-490	49"	20.80	MXV5-690	69"	25.92	MXV5-890	89"	33.12	MXV5-1180	118"	49.91
MXV5-500	50"	21.12	MXV5-700	70"	26.16	MXV5-900	90"	33.44	MXV5-1200	120"	50.76
MXV5-510	51"	21.44	MXV5-710	71"	26.40	MXV5-910	91"	33.76	MXV5-1260	126"	53.30
MXV5-520	52"	21.76	MXV5-720	72"	26.72	MXV5-920	92"	34.08	MXV5-1340	134"	56.68
MXV5-530	53"	22.08	MXV5-730	73"	27.12	MXV5-930	93"	34.40	MXV5-1360	136"	57.53
MXV5-540	54"	22.40	MXV5-740	74"	27.44	MXV5-940	94"	34.88	MXV5-1380	138"	58.37
MXV5-550	55"	22.64	MXV5-750	75"	27.76	MXV5-950	95"	35.44	MXV5-1390	139"	58.80
MXV5-560	56"	22.80	MXV5-760	76"	28.08	MXV5-960	96"	36.00	MXV5-1400	140"	59.22
MXV5-570	57"	23.04	MXV5-770	77"	28.48	MXV5-970	97"	36.40	MXV5-1430	143"	60.49
MXV5-580	58"	23.20	MXV5-780	78"	28.80	MXV5-980	98"	36.80	MXV5-1480	148"	62.60
MXV5-590	59"	23.36	MXV5-790	79"	29.20	MXV5-990	99"	37.20	MXV5-1520	152"	64.30
MXV5-600	60"	23.52	MXV5-800	80"	29.60	MXV5-1000	100"	37.60	MXV5-1630	163"	68.95
MXV5-610	61"	23.92	MXV5-810	81"	30.00	MXV5-1010	101"	42.42			
MXV5-620	62"	23.84	MXV5-820	82"	30.40	MXV5-1020	102"	42.84			

POPULAR BRAND SIZE/PRODUCT NUMBER COMPARISON

So consumers may select high-quality **Jason MXV** replacement belts for all of their requirements, regardless of brand, this chart will help you convert other manufacturers' product numbers to those supplied by Jason Industrial.

Belt Size	Jason MXV	Carlisle PT X-D-V	Gates Powerated	Goodyear Insta-Power	Dayco GPL	Thermoid Power Plus
Example: 36" O.L. 3 ³ / ₈ " Top Width	MXV3-360	38x360	6736	83360	L336	3H360
Example: 38" O.L. 1 ¹ / ₂ " Top Width	MXV4-380	48x360	6838	84380	L438	4H380
Example: 42" O.L. 5 ⁵ / ₈ " Top Width	MXV5-420	58x420	6942	85420	L542	5H420

Centrifugal (PTO) Replacement Belts

for: **Ace Centrifugal Pump – Model PTOC/H600-10, 1000-10, 600-10B**
Model CPK Centrifugal Sprayer Pump

Belt Number	Description	Fits Model Number
BAC-28-8	Poly-V belt, 8 Groove	PTOC-540, 600, 600B, 600D
AC-28-8M	Poly-V belt, 8 Groove	PTOC-1000, 1000B
BAC-28-10	Poly-V belt, 10 Groove	PTOC-600-10, 600-10B
BAC-28-10M	Poly-V belt, 10 Groove	PTOC-1000-10, 1000-10B
BAC-28-10-150	Poly-V belt, 10 Groove	PTOC RPM, 1000 RPM
BAC-28-10M-150	Poly-V belt, 10 Groove	PTOC PPMB, 1000 RPMB
CPK-28-2	Polyflex, set 2 ea.	CPK Sprayer Pump, 3450 RPM
FMK-28-2M	Neoflex, set 2ea.	1000 RPM, Front PT

for: **Hypro (belt drive) Centrifugal Pump – Model 9401C (600 RPM PTO)**
Model 9401C-1000 (1000 RPM PTO)

540J12	Poly-V belt, 12 Groove	9403-540S
3100-0005	Poly-V belt, 12 Groove	540 RPM
3100-0006	Poly-V belt, 12 Groove	1000 RPM
3103-0004	Polyflex, set 2 ea.	9200-540 RPM
3103-0005	Polyflex, set 2 ea.	9200-1000 RPM
3103-0009 (ST876)	Timing Belt, 345L100	9401-6000 RPM
3103-0010 (ST686)	Timing Belt, 270L100	9401-1000 RPM

POPULAR O.E.M. REPLACEMENT BELTS

Special size belts specifically manufactured to fit and perform to O.E.M. application.

Replacement For	O.E.M. Jason No.	Model	Application
BOBCAT RANSOMES	38017N	3605, 06, 11, 4805, SM-XM4806	Wheel Traction Drive
	38212		Traction Wheel Drive (Dual Rib)
	38249	M36, M48, M32	Traction Wheel Drive (Dual Rib)
	38523		Traction Wheel Drive (Dual Rib)
BUNTON	PL0643	B28, 32, 36, 48, 52	Blade to Blade
	PL4275	36", 48" & 52" Mid Size	Traction Wheel Drive (Dual Rib)
EXMARK	323288	Dual Wheel Drive	36", 48" & 52" Cut, Metro
GRAVELY	11-216	51213, 11216, 72266	50" Cut, Deck Drive
MTD	754-0280	130-650 to 130-659	Engine to V/S Drive
	754-0281	134-620, 134-631	Trans. to V/S Drive
	754-0283	195-746	Tractor Deck Drive 95"
	754-0329, 0433	600, 805	38" Engine to Deck
	754-0346	314-640F-642F- 646F-660G-666G	Self-Propell, 462R, 479R
	754-0349	130-800 to 130-809	46" Blade Drive
	754-0350	130-800 to 130-809	46" Deck to Engine
	754-0358	140-180, 800	V/S to Trans, 46" Deck
	754-0362	820-849 2-Speed	V/S to Trans, 46" Deck
	754-0367	140-181 Single Stage	Snowblower, Auger
	754-0370	600-689, 750-769	V/S to Transmission
	754-0371	131-6506000, 600	42" Engine to Deck
	754-0433, 0329	600, 805	38" Side Discharge
	754-0434	430, 440 & 450	Engine to Transmission
	754-0438	410 & 420	Tiller, Trans to Engine
	754-0439	600, 1999 & after	46" Deck to Engine
	754-0440	600 Rider	46" Deep Deck
	754-0441	600 Hydrostatic	Trans. to Engine
	754-0444		V/S to Trans, Tractor Deck
	754-0446	In Development	Vari Speed to Trans
	754-0453	Yard Bug	27.5" Deck V/S to Trans
	754-0461	800 Series Hydrostatic 1997+	Trans. Pulley to Engine
	754-0465	400, 500 Series	Engine to Transmission
754-0468	Auto Drive Step Tractor	42", 46" Deck V.S. to Trans.	
754-0474	Auto Drive Step Tractor	46" Deck to Lower Engine	
754-0475	Auto Drive Step Tractor	50" Deck to Lower Engine	
754-0476	Auto Drive Step Tractor	46" Deck to Lower Engine	
754-0486	Auto Drive Step Tractor	46" Deck to Lower Engine	
754-0487	Auto Drive Step Tractor	46" Deck to Lower Engine	
754-0497	Revolution, Step Thru Frame	42" Deck Pulley to Lower Engine	

Special size belts specifically manufactured to fit and perform to O.E.M. application.

POPULAR O.E.M. REPLACEMENT BELTS

Replacement For	O.E.M. Jason No.	Model	Application
MURRAY			
	37x43	5-36506-508	Blade Drive, Uni-Frame
	37x56	8-35500	Blade Drive
	37x66	46300 Series	18 Hp, 46" cut Blade to Blade
	37x75	12-18 hp, 1990-94	42" Blade Drive (Set 2 ea.)
	42111		Rear Engine to Blade
POULAN/AYP/SEARS/YARD PRO			
	138255	917-252931, 930, 262683 252674	Secondary Deck Drive, 50" Cut
	140294	POULAN PP12008	42" Hydro, Ground
	144200	POULAN PP12001	38" Primary Deck
	144959	POULAN PP12012	42" Primary Deck
	174368	POULAN PP13007	48" Hydro Elec., Primary
	180808	POULAN PP13008	48" Hydro Elec., Secondary
SCAG			
	48202	SW-36, 48, 52	36", 48" & 52" Traction Wheel Drive (Dual Rib)
	48587	Hydro Models	Pump Drive, 20" Deck
SNAPPER			
	1-0749	2810, 2880, 3010, 3081	25", 30" Rear Engine
	1-2353	21PC, 21500C, PC, TC	5Hp Comm. Blade Drive
	1-2354	21P, 21351, 21401, 02, 02P	V21 Trans. Self-Propelled
	1-2508	21P, 21351, 21401, 02, 02P	V21, 3.5/4.0Hp Engine
	1-7333		36", 48", 52", 61" Cut, Walk
	1-8236, 2-2252	Rear Engine Riders	25" - 33" Deck
SWISHER			
	7-5570	A32 1S, 2S	Engine to Blade
	BA-58, 43-3368	T40	Engine to Blade

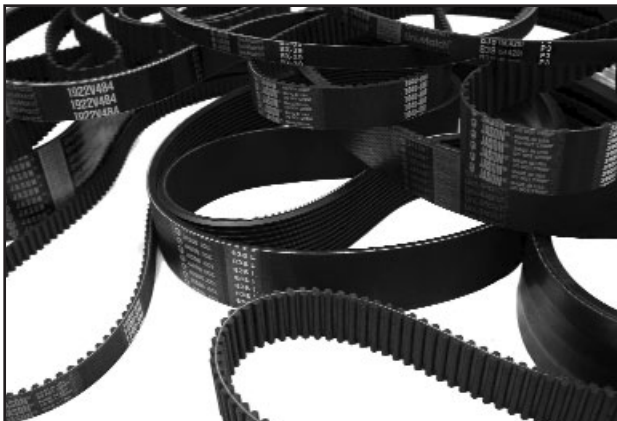

Jason Industrial Offers a Full Line of Belting

- Synchronous Neoprene Timing Belts
- Urethane Belts
- Variable Speed V-Belts
- Metric Belts
- Multi-Rib V-Belts
- Double Multiple V-Belts
- MXV Super Duty Belts
- 400 Flat and Neoflex Belts

LAWN AND GARDEN EQUIPMENT PART NUMBERS

NOTE: FHP Belt may be upgraded to the MXV Belt, however the FHP Belt SHOULD NOT be substituted for the MXV Belt

Alphabetical sequence by manufacturer

OEM #	Belt No.	OEM #	Belt No.	OEM #	Belt No.	OEM #	Belt No.	OEM #	Belt No.
BOBCAT/ RANSOMES		EXMARK		MTD		MTD		MURRAY	
38015N.....	MXV5-870	303080A.....	MXV5-890	754-0184.....	MXV4-520	754-0284.....	MXV5-410	20556.....	MXV4-480
38016N.....	MXV5-360	323288.....	51-4290	754-0185.....	MXV4-490	754-0285.....	MXV4-340	20557.....	MXV4-460
38017N.....	BX42	403024.....	MXV5-940	754-0186.....	MXV4-820	754-0290.....	MXV4-470	20558.....	MXV4-640
38030.....	MXV5-930	403025.....	MXV5-520	754-0188.....	MXV5-510	754-0291.....	MXV4-880	20715.....	MXV4-370
38031.....	MXV5-520	413094.....	MXV5-1040	754-0189.....	MXV4-440	754-0292.....	MXV4-260	20716.....	MXV4-370
38038.....	MXV5-960	603045.....	MXV4-1112	754-0190.....	MXV4-390	754-0293.....	MXV4-740	20717.....	MXV4-560
38039N.....	MXV5-820	603306.....	MXV5-810	754-0191.....	MXV4-650	754-0294.....	MXV4-890	21058.....	MXV4-630
38075.....	B79			754-0192.....	MXV4-340	754-0299.....	MXV4-490	20159.....	MXV4-440
38076.....	B84	GRAVELY		754-0193.....	MXV4-350	754-0325.....	MXV4-570	21614.....	MXV4-850
38077.....	MXV5-930	11-216.....	11-216	754-0194.....	MXV4-450	754-0327.....	MXV5-280	21615.....	MXV4-950
38111.....	MXV5-870	51213.....	11-216	754-0195.....	MXV4-540	754-0328.....	MXV5-490	21649.....	MXV4-550
38212.....	38212	72224.....	AX45(2)	754-0196.....	MXV4-300	754-0329.....	MXV5-690	26611.....	MXV3-380
38234.....	MXV5-910	72250.....	AX35	754-0197.....	A115	754-0339.....	MXV4-790	22846.....	MXV3-410
38249.....	38249	72258.....	AX51(2)	754-0198.....	MXV4-620	754-0340.....	MXV5-840	23072.....	MXV4-430
38439.....	MXV5-690	72266.....	11-216	754-0200.....	MXV4-480	754-0342.....	MXV4-680	23098.....	MXV4-620
38440.....	B82	7225800.....	AX51(2)	754-0201.....	MXV4-410	754-0343.....	MXV3-310	23214.....	MXV4-590
2188134.....	MXV-1010	49029.....	AX45(2)	754-0203.....	MXV5-610	754-0346.....	MXV3-300	23223.....	MXV4-950
38442.....	MXV5-680	51213.....	11-216	754-0204.....	MXV4-670	754-0347.....	MXV4-630	23347.....	MXV4-840
38523.....	38523			754-0206.....	MXV4-500	754-0349.....	A77	23496.....	MXV4-740
39116.....	MXV5-690	HUSQVARNA		754-0207.....	MXV4-420	754-0350.....	MXV5-640	23748.....	MXV4-620
78030.....	MXV3-260	KEES/YAZOO		754-0210.....	MXV5-600	754-0355.....	MXV4-670	23749.....	MXV4-990
78031.....	MXV3-360	205-505.....	AA80	754-0211.....	MXV5-460	754-0358.....	754-0358	23796.....	MXV4-590
108024.....	MXV5-460	532-138498.....	MXV4-960	754-0212.....	MXV5-470	754-0362.....	754-0362	23853.....	MXV4-430
108025.....	MXV5-520	532-140294.....	MXV4-820	754-0213.....	MXV4-530	754-0364.....	MXV5-680	23882.....	MXV4-590
108071.....	MXV5-530	532-191273.....	MXV5-1430	754-0215.....	MXV4-1070	754-0365.....	MXV4-830	24256.....	MXV4-880
BUNTON		532-191273.....	MXV5-1430	754-0216.....	MXV3-290	754-0367.....	754-0367	24304.....	MXV4-830
PL0019.....	MXV4-360	539-103241.....	MXV4-600	754-0217.....	MXV5-790	754-0369.....	MXV3-390	42111.....	42111
PL0020.....	MXV4-370	539-103687.....	MXV5-1520	754-0218.....	MXV5-590	754-0370.....	MXV5-490	75121.....	MXV4-380
PL0021.....	MXV4-390	539-107709.....	MXV5-1430	754-0219.....	MXV4-260	754-0371.....	MXV5-680	75147.....	MXV3-390
PL0148.....	MXV4-280	539-107710.....	MXV4-650	754-0220.....	MXV5-270	754-0374.....	MXV3-190	314572.....	314572
PL0511.....	MXV5-540			754-0221.....	MXV5-520	754-0377.....	MXV4-710	321205.....	MXV5-970
PL0543.....	MXV4-430	MTD		754-0222.....	MXV4-440	754-04122.....	MXV4-900	37x1.....	MXV4-410
PL0619.....	MXV5-440	754-0101.....	MXV4-350	754-0223.....	MXV3-360	754-0428.....	MXV4-420	37x2.....	MXV4-480
PL0643.....	PL0643	754-0103.....	MXV4-270	754-0224.....	MXV5-260	754-0433.....	MXV5-690	37x3.....	MXV4-460
PL0661.....	MXV5-580	754-0104.....	MXV4-320	754-0225.....	MXV4-1070	754-0434.....	754-0434	37x4.....	MXV4-640
PL0679.....	MXV5-660	754-0105.....	MXV4-300	754-0226.....	MXV4-820	754-0438.....	754-0438	37x5.....	MXV4-370
PL0848.....	MXV5-400	754-0106.....	MXV4-250	754-0227.....	MXV5-630	754-0439.....	MXV5-600	37x6.....	MXV4-370
PL0861.....	MXV5-460	754-0107.....	MXV4-300	754-0228.....	MXV5-620	754-0440.....	MXV4-1000	37x7.....	MXV4-560
PL4275.....	PL4275	754-0108.....	MXV4-460	754-0229.....	MXV4-520	754-0441.....	A75	37x8.....	MXV4-630
CUB CADET		754-0109.....	MXV4-430	754-0230.....	MXV4-560	754-0443.....	AA90	37x9.....	MXV4-440
106465.....	MXV4-510	754-0111.....	MXV4-450	754-0231.....	MXV4-280	754-0444.....	754-0444	37x10.....	MXV4-850
106990.....	MXV4-450	754-0112.....	MXV5-800	754-0232.....	MXV4-200	754-0446.....	754-0446	37x11.....	MXV4-950
106991.....	MXV4-550	754-0113.....	MXV5-480	754-0233.....	MXV4-210	754-0453.....	MXV5-360	37x12.....	MXV4-550
135469.....	MXV5-890	754-0114.....	MXV4-240	754-0234.....	MXV4-410	754-0465.....	MXV3-360	37x13.....	MXV3-410
473468R2.....	MXV4-720	754-0115.....	MXV5-610	754-0235.....	MXV4-350	754-0467.....	MXV5-920	37x14.....	MXV4-430
488077R1.....	MXV4-480	754-0118.....	MXV5-630	754-0236.....	MXV4-850	754-0468.....	MXV5-420	37x15.....	MXV4-620
489399R1.....	MXV4-800	754-0121.....	MXV4-320	754-0238.....	MXV4-920	754-0472.....	MXV5-830	37x16.....	MXV4-590
490489R2.....	MXV4-810	754-0125.....	MXV4-1050	754-0239.....	MXV4-290	754-0475.....	MXV5-1090	37x17.....	MXV4-940
493649R1.....	MXV4-730	754-0127.....	MXV5-660	754-0240.....	MXV5-380	754-0487.....	MXV5-660	37x18.....	MXV4-820
754-04033.....	MXV4-1180	754-0128.....	MXV5-350	754-0241.....	MXV5-350	754-0754.....	MXV5-520	37x19.....	MXV4-740
754-04044.....	MXV4-1340	754-0129.....	MXV5-440	754-0242.....	MXV4-320	754-0935.....	MXV4-310	37x20.....	MXV4-770
754-04045.....	MXV4-1090	754-0135.....	MXV5-250	754-0243.....	MXV4-460	754-0936.....	MXV4-470	37x21.....	MXV4-620
754-04064.....	MXV5-680	754-0136.....	MXV5-310	754-0244.....	MXV4-400	754-0937.....	MXV5-590	37x22.....	MXV4-990
754-04077.....	MXV5-1340	754-0137.....	MXV4-300	754-0245.....	MXV4-590	754-3003.....	MXV5-900	37x23.....	MXV4-430
754-0640.....	MXV5-790	754-0138.....	MXV5-500	754-0247.....	MXV4-560	954-04001.....	MXV5-700	37x24.....	MXV4-590
754-3055.....	MXV5-1130	754-0142.....	MXV4-310	754-0248.....	MXV4-890	954-04002.....	MXV5-320	37x26.....	MXV4-880
754-3068.....	MXV5-1110	754-0144.....	MXV5-550	754-0249.....	MXV5-300	954-04060B.....	MXV4-970	37x27.....	MXV4-830
954-04062.....	MXV4-780	754-0145.....	MXV5-690	754-0250.....	MXV4-530	754-04122.....	MXV4-900	37x28.....	MXV4-480
954-04077.....	MXV5-1340	754-0146.....	MXV4330	754-0251.....	MXV4-510	954-0453.....	MXV5-360	37x29.....	MXV3-390
954-0640.....	MXV5-790	754-0147.....	MXV5-520	754-0252.....	MXV4-330	954-0461.....	MXV4-790	37x30.....	MXV4-250
954-0644.....	MXV4-600	754-0148.....	MXV5-280	754-0253.....	MXV4-430	954-0467.....	MXV5-920	37x31.....	MXV4-930
954-0645.....	MXV4-670	754-0157.....	MXV5-280	754-0255.....	MXV4-370	954-0468.....	MXV5-420	37x32.....	MXV4-550
954-3036.....	MXV4-630	754-0158.....	MXV5-350	754-0256.....	MXV4-290	954-0474.....	MXV5-1020	37x33.....	MXV4-910
954-3038.....	MXV4-610	754-0163.....	MXV4-280	754-0257.....	MXV3-380	954-0476.....	MXV5-1010	37x34.....	MXV4-770
954-3073.....	MXV4-620	754-0164.....	MXV4-630	754-0261.....	MXV4-560	954-0485.....	MXV5-970	37x35.....	MXV4-910
EXMARK		754-0165.....	MXV4-340	754-0264.....	MXV4-520	954-0486.....	MXV5-670	37x36.....	MXV4-550
213076.....	MXV4-290	754-0166.....	MXV5-620	754-0266.....	MXV4-850	954-0497.....	MXV4-600	37x37.....	MXV4-500
213077.....	MXV4-370	754-0167.....	MXV5-640	754-0267.....	MXV4-590	954-0498.....	MXV4-670	37x38.....	MXV4-400
303078.....	MXV5-360	754-0173.....	MXV5-370	754-0268.....	MXV5-510	954-0642.....	MXV5-1380	37x40.....	MXV4-620
303079.....	B41	754-0177.....	MXV4-320	754-0271.....	MXV3-390			37x43.....	37x43
		754-0178.....	MXV5-820	754-0275.....	MXV4-380	MURRAY		37x44.....	MXV4-500
		754-0179.....	MXV4-490	754-0278.....	MXV4-300	1001223.....	AA73	37x45.....	MXV4-910
		754-0180.....	MXV5-540	754-0280.....	754-0280	201153.....	MXV4-620	37x46.....	MXV4-270
		754-0181.....	MXV4-1000	754-0281.....	754-0281	20159.....	MXV4-440	37x47.....	MXV4-910
		754-0182.....	MXV5-810	754-0282.....	MXV4-390	20555.....	MXV4-410	37x49.....	MXV3-400
		754-0183.....	MXV5-290	754-0283.....	MXV4-950			37x50.....	MXV4-540

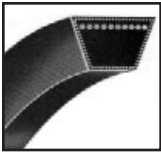

F.H.P. V-BELTS

3L SECTION 3/8" Top x 7/32" Thick x 40° Angle

Belt Number	Outside Length	List Each	Belt Number	Outside Length	List Each	Belt Number	Outside Length	List Each	Belt Number	Outside Length	List Each
3L130	13"	\$ 4.72	3L290	29"	\$5.04	3L450	45"	\$6.56	3L610	61"	7.92
3L140	14"	4.72	3L300	30"	5.12	3L460	46"	6.64	3L620	62"	8.00
3L150	15"	4.72	3L310	31"	5.16	3L470	47"	6.76	3L630	63"	8.08
3L160	16"	4.72	3L320	32"	5.24	3L480	48"	6.84	3L640	64"	8.16
3L170	17"	4.72	3L330	33"	5.32	3L490	49"	6.92	3L650	65"	8.32
3L180	18"	4.72	3L340	34"	5.40	3L500	50"	7.00	3L660	66"	8.40
3L190	19"	4.72	3L350	35"	5.52	3L510	51"	7.08	3L670	67"	8.52
3L200	20"	4.72	3L360	36"	5.60	3L520	52"	7.16	3L680	68"	8.60
3L210	21"	4.72	3L370	37"	5.72	3L530	53"	7.24	3L690	69"	8.72
3L220	22"	4.72	3L380	38"	5.84	3L540	54"	7.32	3L700	70"	8.80
3L230	23"	4.72	3L390	39"	5.96	3L550	55"	7.40	3L710	71"	8.92
3L240	24"	4.72	3L400	40"	6.08	3L560	56"	7.48	3L720	72"	9.00
3L250	25"	4.72	3L410	41"	6.20	3L570	57"	7.56	3L730	73"	9.08
3L260	26"	4.80	3L420	42"	6.28	3L580	58"	7.72	3L740	74"	9.20
3L270	27"	4.88	3L430	43"	6.36	3L590	59"	7.72	3L750	75"	9.20
3L280	28"	4.96	3L440	44"	6.44	3L600	60"	7.80	3L760	76"	9.20

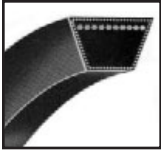

*MULTI-PLUS® V-BELTS

"A" SECTION 1/2" Top x 11/32" Thick x 40° Angle

A15 (4L170)	17"	4.96	A46 (4L480)	48"	\$7.20	A78 (4L800)	80"	\$10.40	A110	112"	15.60
A16 (4L180)	18"	4.96	A47 (4L490)	49"	7.32	A79 (4L810)	81"	10.64	A111	113"	15.80
A17 (4L190)	19"	4.96	A48 (4L500)	50"	7.40	A80 (4L820)	82"	10.80	A112	114"	16.00
A18 (4L200)	20"	4.96	A49 (4L510)	51"	7.48	A81 (4L830)	83"	11.00	A113	115"	16.32
A19 (4L210)	21"	5.00	A50 (4L520)	52"	7.52	A82 (4L840)	84"	11.12	A114	116"	16.32
A20 (4L220)	22"	5.00	A51 (4L530)	53"	7.60	A83 (4L850)	85"	11.28	A115	117"	16.46
A21 (4L230)	23"	5.08	A52 (4L540)	54"	7.64	A84 (4L860)	86"	11.40	A116	118"	16.64
A22 (4L240)	24"	5.08	A53 (4L550)	55"	7.80	A85 (4L870)	87"	11.60	A118	120"	16.92
A23 (4L250)	25"	5.12	A54 (4L560)	56"	8.00	A86 (4L880)	88"	11.76	A119	121"	17.20
A24 (4L260)	26"	5.16	A55 (4L570)	57"	8.00	A87 (4L890)	89"	11.92	A120	122"	17.20
A25 (4L270)	27"	5.20	A56 (4L580)	58"	8.20	A88 (4L900)	90"	12.08	A124	126"	17.80
A26 (4L280)	28"	5.20	A57 (4L590)	59"	8.24	A89 (4L910)	91"	12.24	A128	130"	18.40
A27 (4L290)	29"	5.28	A58 (4L600)	60"	8.28	A90 (4L920)	92"	12.40	A130	132"	18.68
A28 (4L300)	30"	5.40	A59 (4L610)	61"	8.32	A91 (4L930)	93"	12.56	A133	135"	19.12
A29 (4L310)	31"	5.48	A60 (4L620)	62"	8.40	A92 (4L940)	94"	12.68	A134	136"	19.20
A30 (4L320)	32"	5.60	A61 (4L630)	63"	8.52	A93 (4L950)	95"	12.80	A135	137"	19.44
A31 (4L330)	33"	5.60	A62 (4L640)	64"	8.60	A94 (4L960)	96"	12.96	A136	138"	19.44
A32 (4L340)	34"	5.68	A63 (4L650)	65"	8.80	A95 (4L970)	97"	13.08	A137	139"	19.44
A33 (4L350)	35"	5.80	A64 (4L660)	66"	8.92	A96 (4L980)	98"	13.20	A140	142"	20.56
A34 (4L360)	36"	5.88	A65 (4L670)	67"	9.00	A97 (4L990)	99"	13.36	A144	146"	22.56
A35 (4L370)	37"	6.00	A66 (4L680)	68"	9.00	A98 (4L1000)	100"	13.52	A157	159"	22.60
A36 (4L380)	38"	6.00	A67 (4L690)	69"	9.12	A99	101"	13.62	A158	160"	22.60
A37 (4L390)	39"	6.00	A68 (4L700)	70"	9.20	A100	102"	13.76	A162	164"	23.00
A38 (4L400)	40"	6.40	A69 (4L710)	71"	9.60	A101	103"	14.00	A173	175"	24.00
A39 (4L410)	41"	6.64	A70 (4L720)	72"	9.60	A102	104"	14.00	A180	182"	24.60
A40 (4L420)	42"	6.68	A71 (4L730)	73"	9.64	A103	105"	14.14	A196	198"	25.50
A41 (4L430)	43"	6.72	A72 (4L740)	74"	9.72	A104	106"	14.08	A197	199"	26.50
A42 (4L440)	44"	6.80	A73 (4L750)	75"	9.80	A105	107"	14.40	A210	109"	28.42
A43 (4L450)	45"	7.00	A74 (4L760)	76"	9.88	A106	108"	14.80	A221	212"	29.73
A44 (4L460)	46"	7.04	A75 (4L770)	77"	10.00	A107	109"	14.80	A256	258"	45.88
A45 (4L470)	47"	7.12	A76 (4L780)	78"	10.16	A108	110"	15.20	A258	260"	45.88
			A77 (4L790)	79"	10.24	A109	111"	15.60			

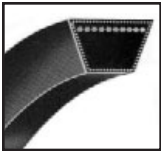

*MULTI-PLUS® V-BELTS

"B" SECTION 21/32" Top x 7/16" Thick x 40° Angle

B20	23"	6.08	B29 (5L320)	32"	7.68	B40 (5L430)	43"	9.16	B51 (5L540)	54"	11.20
B21 (5L240)	24"	6.08	B30 (5L330)	33"	7.72	B41 (5L440)	44"	9.20	B52 (5L550)	55"	11.24
B22 (5L250)	25"	6.80	B31 (5L340)	34"	7.80	B42 (5L450)	45"	9.60	B53 (5L560)	56"	11.40
B23 (5L260)	26"	7.00	B32 (5L350)	35"	7.84	B43 (5L460)	46"	9.72	B54 (5L570)	57"	11.52
B24 (5L270)	27"	7.20	B33 (5L360)	36"	7.96	B44 (5L470)	47"	9.72	B55 (5L580)	58"	11.60
B25 (5L280)	28"	7.40	B34 (5L370)	37"	7.96	B45 (5L480)	48"	10.00	B56 (5L590)	59"	11.68
B26 (5L290)	29"	7.52	B35 (5L380)	38"	8.00	B46 (5L490)	49"	10.40	B57 (5L600)	60"	11.72
B27 (5L300)	30"	7.56	B36 (5L390)	39"	8.20	B47 (5L500)	50"	10.46	B58 (5L610)	61"	11.76
B28 (5L310)	31"	7.60	B37 (5L400)	40"	8.60	B48 (5L510)	51"	10.80	B59 (5L620)	62"	11.96
			B38 (5L410)	41"	8.80	B49 (5L520)	52"	10.88	B60 (5L630)	63"	12.00
			B39 (5L420)	42"	9.08	B50 (5L530)	53"	11.00	B61 (5L640)	64"	12.20

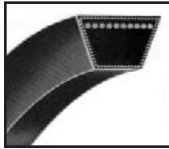

***MULTI-PLUS® V-BELTS**
"B" SECTION 21/32" Top x 7/16" Thick x 40° Angle

Belt Number	Outside Length	List Each	Belt Number	Outside Length	List Each	Belt Number	Outside Length	List Each	Belt Number	Outside Length	List Each
B62 (5L650)	65"	12.40	B96 (5L990)	99"	18.20	B134	137"	25.08	B205	208"	40.00
B63 (5L660)	66"	12.48	B97 (5L1000)	100"	18.80	B135	138"	25.20	B210	213"	40.00
B64 (5L670)	67"	12.56	B98 (5L1010)	101"	18.92	B136	139"	25.60	B215	216"	40.94
B65 (5L680)	68"	12.64	B99 (5L1000)	102"	19.16	B138	141"	26.00	B221	222"	41.00
B66 (5L690)	69"	12.96	B100	103"	19.16	B140	143"	26.60	B223	224"	42.24
B67 (5L700)	70"	13.08	B101	104"	19.28	B141	144"	27.00	B224	225"	42.40
B68 (5L710)	71"	13.20	B102	105"	19.40	B142	145"	27.19	B225	226"	42.60
B69 (5L720)	72"	13.76	B103	106"	19.48	B144	147"	27.60	B228	229"	43.08
B70 (5L730)	73"	14.00	B104	107"	19.60	B147	150"	28.40	B229	230"	43.28
B71 (5L740)	74"	14.08	B105	108"	20.00	B148	151"	28.40	B234	235"	44.07
B72 (5L750)	75"	14.20	B106	109"	20.40	B150	153"	28.64	B237	238"	45.20
B73 (5L760)	76"	14.28	B107	110"	20.60	B152	155"	29.00	B240	241"	45.20
B74 (5L770)	77"	14.36	B108	111"	20.68	B153	156"	29.16	B248	249"	47.20
B75 (5L780)	78"	14.40	B109	112"	20.96	B154	157"	29.32	B253	254"	48.36
B76 (5L790)	79"	14.72	B110	113"	21.16	B156	159"	29.84	B255	256"	48.80
B77 (5L800)	80"	14.96	B111	114"	21.36	B157	160"	29.84	B259	260"	49.44
B78 (5L810)	81"	15.00	B112	115"	21.60	B158	161"	30.00	B265	266"	50.25
B79 (5L820)	82"	15.24	B113	116"	22.00	B162	165"	30.80	B270	271"	51.20
B80 (5L830)	83"	15.48	B114	117"	22.00	B163	166"	31.00	B276	277"	52.00
B81 (5L840)	84"	15.60	B115	118"	22.08	B165	168"	31.50	B285	286"	53.20
B82 (5L850)	85"	15.80	B116	119"	22.20	B168	171"	32.80	B292	293"	55.29
B83 (5L860)	86"	16.12	B118	121"	22.52	B170	173"	32.80	B293	294"	55.29
B84 (5L870)	87"	16.20	B120	123"	22.80	B173	176"	32.80	B300	301"	56.80
B85 (5L880)	88"	16.40	B122	125"	23.60	B175	178"	33.28	B315	316"	59.60
B86 (5L890)	89"	16.56	B123	126"	23.60	B177	180"	33.84	B330	331"	62.40
B87 (5L900)	90"	16.72	B124	127"	23.60	B180	183"	34.40	B333	334"	63.00
B88 (5L910)	91"	16.88	B125	128"	23.60	B182	185"	35.16	B345	346"	65.40
B89 (5L920)	92"	17.04	B126	129"	24.00	B184	187"	35.16	B360	361"	80.00
B90 (5L930)	93"	17.20	B127	130"	24.20	B188	191"	36.27	B394	395"	87.56
B91 (5L940)	94"	17.36	B128	131"	24.40	B190	193"	36.27	B433	434"	96.23
B92 (5L950)	95"	17.52	B130	133"	24.64	B192	195"	36.64	B472	473"	104.88
B93 (5L960)	96"	17.68	B131	134"	24.88	B195	198"	37.20			
B94 (5L970)	97"	17.88	B132	135"	24.88	B197	200"	37.61			
B95 (5L980)	98"	18.04	B133	136"	25.00	B204	207"	38.88			

*UniMatch® series belts ensure all belts are same size and type will measure within RMA matching limits. Combination branded i.e. A40 (4L420), B78 (5L810).

V-BELT ACCESSORIES

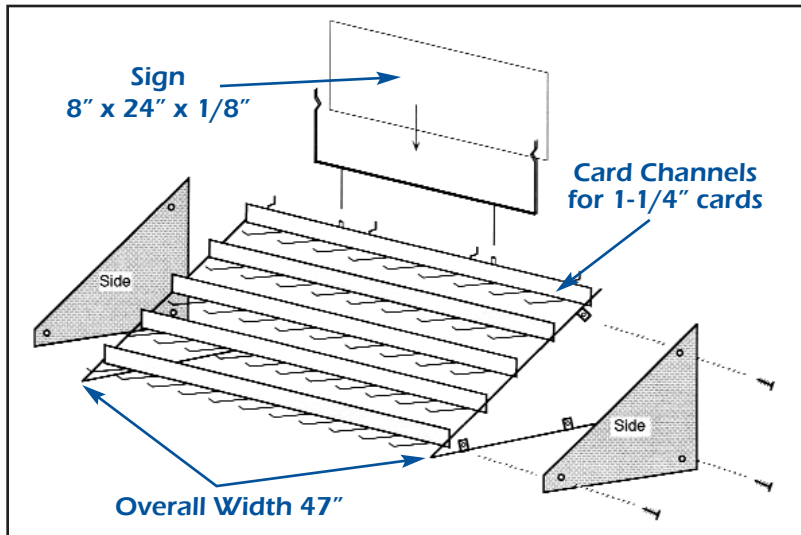

V-BELT DISPLAY

Display up to 184 belts at once. 49 hooks hold up to 4 belts each. Display height is 16", width 47", 22" deep. Includes header sign and bracket accessories for easy set up. **Part No. WFD-42**

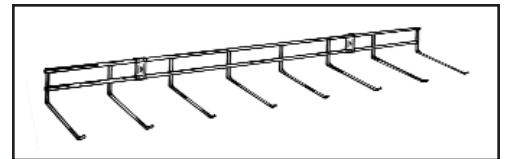

V-BELT WALL RACK

36" long mounting rack with eight 8" hooks provided. Includes two brackets for quick, easy, durable mounting. **Part No. WHD-7**

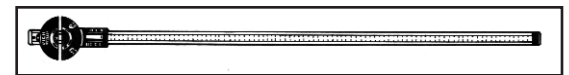

110" BELT MEASURER

Measures all size Industrial belts up to 110" in ranges of 3/8", 1/2" and 5/8" accurately and efficiently. **Part No. 32-9108**

Belt Constructions

MXV™ MEGA-POWER BELT

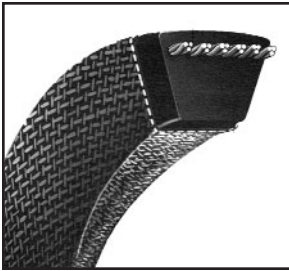

Jason **MXV** belts are recommended for **Heavy Duty Lawn and Garden** equipment, especially where **superior load carrying capacity**, extra heavy **clutching** and **reverse bend** characteristics are required. New length-stable **ARAMID** cord provides **higher tensile strength** and requires fewer take-ups. High quality synthetic compounding results in **longer life** and greater heat and oil resistance.

CROSS SECTIONS AVAILABLE

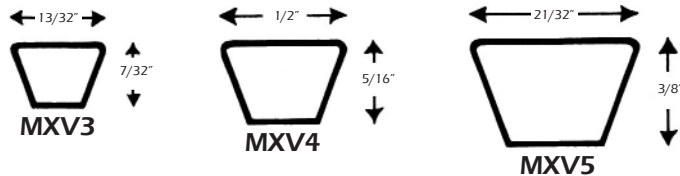

MULTI-PLUS BELT

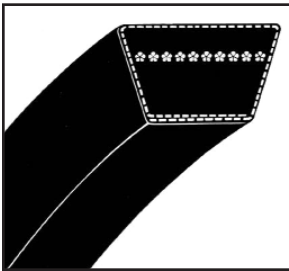

Built with super strength cords, withstands overloads, shocks, vibrations and pulsations; resists extreme temperatures, humidity and excessive oil; high static conductivity.

CROSS SECTIONS AVAILABLE

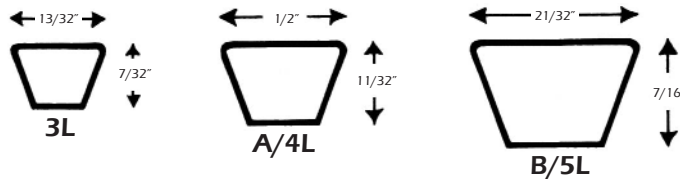

MOLDED COG BELT

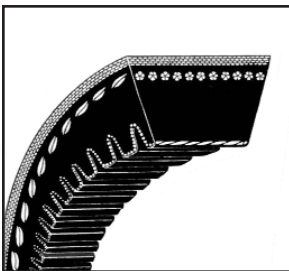

The premier V-Belt for industrial applications; extremely flexible for substandard sheaves; greater horsepower rating for longer service life; operates with lower drive tension. Its combination of molded cogs and Raw-Edge construction allows Jason Cog-Belt to bend more easily around the sheave. This means less energy is wasted so less energy is required from the motor. Belt is static dissipating.

CROSS SECTIONS AVAILABLE

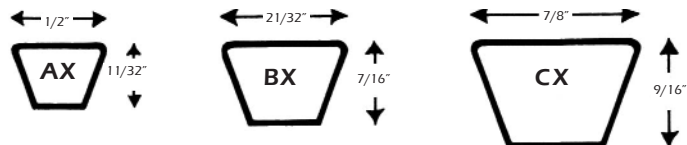

GRIP-FLEX

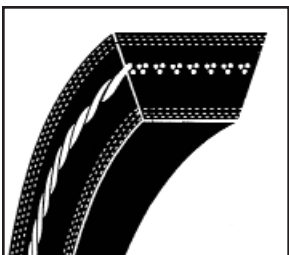

Grip-Flex's stress-relieved bias cut side walls provides maximum flexibility and gripping action while adding increased horsepower capacity. Layers of laminated fabric provide resistance to cracking when engaged in clutching actions. Hi-Modulus polyester or aramid cord specially treated to maintain belt loads without stretching.

Neoprene core rubber provides ideal resistance to flex fatigue, oil and heat degradation.

WEDGE V-BELT

The deep V-design of the **Wedge V-Belt** enables a smaller belt to carry a bigger load. It can operate at higher speeds up to 6,500 feet-per-minute. In most installations, smaller diameter sheaves can be used permitting shorter center distances. Heat and oil resistant, static dissipating.

CROSS SECTIONS AVAILABLE

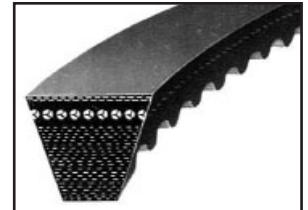
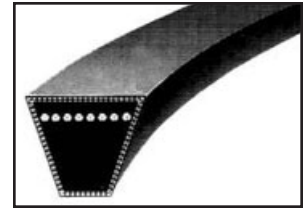
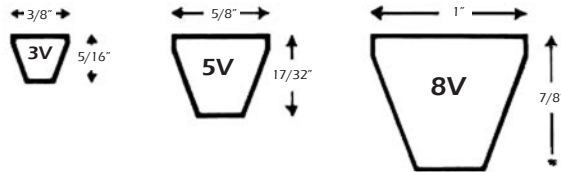

DOUBLE ANGLE V-BELT

For serpentine type drive applications where power must be transmitted to sheaves from both sides of the belt. One or more of the driven sheaves can be operated in a reverse direction without crossing belt. The **Double Angle V-Belt** flexes equally well in either direction and provides natural wedging action on both sides for maximum pulling power regardless of which side of the belt engages the sheave. Belt is static dissipating.

CROSS SECTIONS AVAILABLE

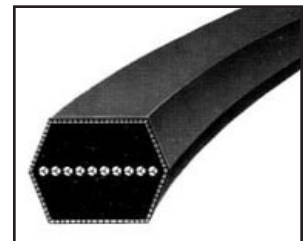
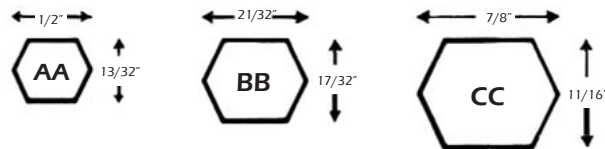

MULTI V-BELT

Delivers 50% more horsepower in two-thirds the space required for standard belts. For high-speed, high-ratio applications where compact drive conditions exist.

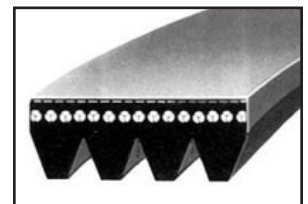
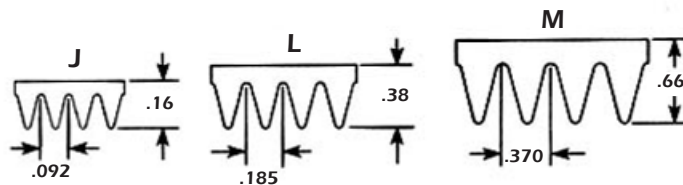

UNI BAND (Machined Edge)

Musclered with high strength, low stretch aramid tension members for extended flex life and excellent resistance to shock loads. **Laminated** style is designed specifically for backside idler operation, lower belt laminations reduce surface fatigue and resist cracking. Where drive application requires secure power engagement over small diameter pulleys, **Molded Cogged** style resists slippage, even at low drive tensions.

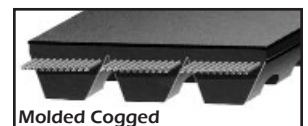
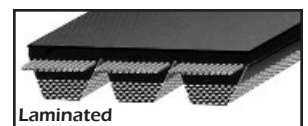

TERMS, CONDITIONS AND LIMITED WARRANTY OF SALE

All prices, terms and conditions of sale are subject to change without prior notice. Buyer agrees to all terms and conditions of seller upon the placement of any and all purchase orders.

GENERAL

- All orders are subject to a minimum charge of \$25.00.
- All claims must be made within seven (7) days of receipt of merchandise.
- The company reserves the right at all times to reject any and all orders for any reason.

PAYMENT TERMS

- Net 30 days (to approved and qualified accounts).
- We reserve the right to hold shipments against past due accounts.
- Seller may require full or partial payment in advance if, in its sole judgement, the financial condition of the buyer does not justify the terms specified.
- All past due accounts are subject to a late payment charge of 1.5% per month, or maximum allowed by law if different, along with the expenses incidental to collection including reasonable attorney's fees.
- Returned checks are subject to a minimum \$50.00 charge.

FREIGHT TERMS

- Freight Prepaid on \$1,000 net.
- Orders with different numbers and dates may not be combined to make freight allowance.
- Prepaid orders requiring immediate delivery that must be shipped from different Jason locations may be subject to a freight surcharge. Such determination will be made at the time of order.
- Backorders will be shipped in the most practical fashion with charges consistent with our freight policy established with the original order.

ACCEPTANCE, ALTERATION AND CANCELLATION OF ORDERS

Orders for other than standard items or standard lengths may not be cancelled after purchase has been committed, production scheduled or any costs incurred.

RETURN OF DEFECTIVE MERCHANDISE

Defective or failed material to be held at the buyer's premises until authorization has been granted by seller to return or dispose of merchandise. Merchandise to be returned for final inspection must be returned Freight Prepaid in the most economical way. Credit will be issued for material found to be defective upon our inspection based on prices at time of purchase.

MERCHANDISE SHIPPED IN ERROR

Buyer must notify seller immediately on any merchandise shipped in error. Upon notification, merchandise is to be returned to seller either via truck on a Freight Collect basis, via carrier of our choice, or via UPS on a Freight Prepaid basis. Buyer will be reimbursed for cost of merchandise, plus any additional freight which may have been incurred due to shipping error.

MERCHANDISE ORDERED IN ERROR

Standard packaged merchandise only may be returned, provided that the merchandise is in the original buyer's possession not more than 30 days. If merchandise is accepted for return, merchandise must be returned Freight Prepaid, and buyer will be charged a minimum of 15% rehandling charge, plus a chargeback for outbound freight charges if the original order was shipped prepaid. Returns are not accepted for any merchandise that is specifically manufactured to meet the buyer's requirement of either specifications or large quantity.

DELIVERY, DAMAGES, SHORTAGES

Delivery to the initial common carrier shall constitute the delivery to the buyer. Our responsibility, insofar as transportation risks are concerned, ceases upon the delivery of the merchandise in good condition to such a carrier, and all the merchandise shall be shipped at the buyer's risk.

GOODS DAMAGED IN SHIPMENT

Upon receipt of shipment, any evidence of damage to original shipping package must be reported by the receiving party and a claim made with the delivering carrier upon receipt of shipment.

CONCEALED DAMAGE

Any evidence of damage to material shipped, upon the opening of the original shipping package, must be reported by the receiving party to and a claim made with the delivering carrier without delay.

LIMITED WARRANTY

The merchandise or products sold or distributed by Jason Industrial, Inc. are warranted to our customers to be free from defects in material and workmanship at the time of shipment by us. All warranty claims shall be made within 90 days after we have shipped the merchandise. Our liability hereunder is limited to the purchase price of any merchandise proved defective, or, at our option, to the replacement of such merchandise upon its authorized return to us.

THIS WARRANTY IS IN LIEU OF AND EXCLUDES ALL OTHER WARRANTIES, EXPRESSED, IMPLIED, STATUTORY, OR OTHERWISE CREATED UNDER APPLICABLE LAW INCLUDING, BUT NOT LIMITED TO, THE WARRANTY OF MERCHANT ABILITY AND THE WARRANTY OF FITNESS FOR A PARTICULAR PURPOSE. IN NO EVENT SHALL WE BE LIABLE FOR SPECIAL, INCIDENTAL, OR CONSEQUENTIAL DAMAGES, INCLUDING LOSS OF PROFITS.



Jason Industrial®



- Power Transmission Belting
- Sheaves, Pulleys & Accessories
- Industrial Hose & Couplings
 - Skirtboard Rubber

Your Industrial Rubber Solution Worldwide!



Fairfield, NJ



Distribution Center
Carol Stream, IL



Tampa, FL



Megadyne America
Charlotte, NC



S.J.M. Belting - Wuxi, China



TBMC - Greenville, SC

Other Jason Industrial Locations:

- Los Angeles, California
- Irving, Texas
- Sorocaba - Sao Paulo Brazil
- Dorval, Quebec Canada
- Mississauga, Ontario Canada
- Edmonton, Alberta Canada
- Azcapotzalco, Mexico

Contact Jason Industrial for additional information. Visit us online at

www.jasonindustrial.com

JASON LAWN & GARDEN REPLACEMENT BELTS

www.jasonindustrial.com

Jason Industrial®



A
MEGADYNE
GROUP COMPANY



All recommendations for the use of the products described herein and all other data or information set forth in this publication, whether concerning such products or otherwise, are furnished without any guarantee, warranty representations or inducement of any kind whether expressed or implied, including but not limited to implied warranties of merchantability and fitness for a particular purpose. And Jason expressly disclaims liability under any theory, including without limitation, contract negligence, misrepresentation or breach of any obligation relating to the recommendation, data or information set forth herein. Readers and customers are encouraged to conduct their own test before using any product. Read its label and all related instructions. The information in this publication is not intended as permission or recommendations to practice a patented invention without permission of the patent owner.

Jason Locations

Corporate Office Central Warehouse

Jason Industrial Inc.

340 Kaplan Drive
Fairfield, NJ 07004
973-227-4904 • FAX: 973-227-1651

Branch Offices & Warehouses

Jason Distribution Center

221 S. Westgate Drive
Carol Stream, IL 60188-2243
630-752-0600 • FAX: 630-752-0680

Jason Industrial Inc.

3236 Royalty Row
Irving, TX 75062
972-438-6992 • FAX: 972-721-9162

Jason Industrial Inc.

3724 East 26th Street
Los Angeles, CA 90023
323-265-8061 • FAX: 323-265-0813

Jason Industrial Inc.

5120-B East Adamo Drive
Tampa, FL 33619
813-241-4111 • FAX: 813-241-4212

Jason Do Brazil Ltda.

Avenida Armando Panunzio 610
Sorocaba - Sao Paulo
Brazil CEP 18050-000
011 55 15 222 00 07
FAX: 011 55 15 222 90 12 or
011 55 15 222 75 65

Jason Industrial Canada Ltd.

9135 Cote De Liesse
Dorval, Quebec H9P-2N9
514-631-6781 • FAX: 514-631-7408

Jason Industrial Canada Ltd.

927 Matheson Blvd, East
Mississauga, Ontario L4W-2R7
905-602-4400 • FAX: 905-602-4406

Jason Industrial Canada Ltd.

10020 42nd Street
Edmonton, Alberta T6E-5B4
780-461-4400 • FAX: 780-461-1034

Jason Industrial, S. De R.L. De C.V.

AV. Ceylan No. 959 Bodega 8
Col. Industrial Vallejo C.P. 02300
Azcapotzalco, Mexico D.F.
011 52 5555873680
FAX: 011 52 5555873688